



FAI Sporting Code

*Fédération
Aéronautique
Internationale*

Section 4 – Aeromodelling

Volume F4 Flying Scale Model Aircraft

2018 Edition

Effective 1st January 2018

- F4B - CONTROL LINE SCALE AEROPLANES
- F4C - RADIO CONTROL SCALE AEROPLANES
- F4H - RADIO CONTROL STAND-OFF SCALE AEROPLANES
- ANNEX 6A - JUDGES' GUIDE – STATIC
- ANNEX 6B - JUDGES' GUIDE – CONTROL LINE FLIGHT
- ANNEX 6C - JUDGES' GUIDE – RADIO CONTROL FLIGHT
- ANNEX 6D - JUDGES' GUIDE – FREE FLIGHT
- ANNEX 6E - FORMS
- ANNEX 6F - JUDGES' GUIDE – STAND-OFF SCALE
- ANNEX 6G - JUDGES' GUIDE – RC FLYING SCALE MODEL HELICOPTERS
- F4A - FREE FLIGHT OUTDOOR SCALE AEROPLANES (Provisional)
- F4D - FREE FLIGHT INDOOR RUBBER SCALE AEROPLANES (Provisional)
- F4E - FREE FLIGHT INDOOR CO₂ OR ELECTRIC SCALE AEROPLANES (Provisional)
- F4F - FREE FLIGHT PEANUT SCALE AEROPLANES (Provisional)
- F4G - RADIO CONTROL LARGE SCALE AEROPLANES (Provisional)
- F4J - RADIO CONTROL TEAM SCALE AEROPLANES (Provisional)
- F4K - RADIO CONTROL SCALE HELICOPTERS (Provisional)

*Maison du Sport International
Avenue de Rhodanie 54
CH-1007 Lausanne
Switzerland
Tel: +41(0)21/345.10.70
Fax: +41(0)21/345.10.77
Email: sec@fai.org
Web: www.fai.org*

FEDERATION AERONAUTIQUE INTERNATIONALE
MSI - Avenue de Rhodanie 54 – CH-1007 Lausanne – Switzerland

Copyright 2018

All rights reserved. Copyright in this document is owned by the Fédération Aéronautique Internationale (FAI). Any person acting on behalf of the FAI or one of its Members is hereby authorised to copy, print, and distribute this document, subject to the following conditions:

- 1. The document may be used for information only and may not be exploited for commercial purposes.**
- 2. Any copy of this document or portion thereof must include this copyright notice.**
- 3. Regulations applicable to air law, air traffic and control in the respective countries are reserved in any event. They must be observed and, where applicable, take precedence over any sport regulations.**

Note that any product, process or technology described in the document may be the subject of other Intellectual Property rights reserved by the Fédération Aéronautique Internationale or other entities and is not licensed hereunder.

ANNEX 6C

CLASS F4C JUDGES' GUIDE - FLYING SCHEDULE

6C.1 General

All flying manoeuvres must be judged bearing in mind the performance of the full size prototype. The aim of the scale flight schedule is to recreate the flight characteristics and realism of the full-size aircraft. Judges must not therefore confuse scale contests with aerobatics contests

The errors mentioned under each manoeuvre cannot be an exhaustive list of all possible faults. They are intended to show the sort of mistakes that are likely during that manoeuvre. These errors examine each manoeuvre from three aspects:

1. The shape, size and technical requirements of the intended manoeuvre.
2. The positioning of the manoeuvre relative to the judges position or other datum.
3. The scale realism achieved relative to the subject aircraft.

It remains the responsibility of the judges to decide upon the importance of each error and deduct marks accordingly, always taking into account the characteristics of the full size aircraft.

Each manoeuvre must be announced prior to commencement and called on commencement by the word "NOW". All flying manoeuvres must be announced upon completion by the word "FINISHED".

The flying judges will be seated alongside the landing area in a line parallel with the wind direction. This axis will be referred to as the "judges' line". The Contest/Flight Line Director will be responsible for the measuring of wind direction. If, in the opinion of the Contest/Flight Line Director, the wind direction continually deviates more than 30° from the judges' line, the judges' line will be adjusted accordingly.

Unless there is a conflict with safety, the pilot should at all times be permitted to choose the direction of take-off and landing to allow for unexpected changes in wind direction. This provision will also apply to manoeuvre 6.3.7.M (Touch-and-Go) since this consists of both a landing and take-off.

Apart from the manoeuvres mentioned above, all manoeuvres must be performed parallel with the judges' line such that if any part of the manoeuvre is performed behind the judges' line it will score ZERO.

In the interests of safety, any manoeuvres overflying a designated area behind the judges' line laid out for the protection of spectators, officials and other competitors or helpers, will score ZERO.

The height and positioning of individual manoeuvres should be proportional to that expected in a full size display typical to each prototype. Unless specified otherwise, manoeuvres that are carried out in a horizontal plane (eg Straight Flight, Figure Eight, Triangular Circuit) should commence on a flight path that is about 60° elevation to the judges. Manoeuvres such as the Descending Circle and Spin should start at a higher elevation. Judges should down mark manoeuvres as too high, too low, too far away, or too close if they consider the positioning to be so.

After each flight, the Flight Judges will record any non-standard event that causes downgrading or loss of flight points. If for any reason the mark awarded is corrected or changed, the change must be initialled by the judge. The Chief Flight Judge will review all flight score sheets for completeness and fairness and justification of any zero scores. As examples: missed manoeuvres, manoeuvres flown out of order, out of flight time, flying behind the "Judges' Line", or crash landing. The Chief Flight Judge must then sign the score sheets before they are sent for processing.

cont/...

6C.3.6.1. Take-Off:

The model aircraft should stand still on the ground with the engine running without being held by the pilot or mechanic and then take-off into wind, or as required by the competitor to make best use of the take-off distance available (jet subjects). If the model aircraft is touched after the competitor calls "Now" the take-off will score zero. The take-off should be straight and the model aircraft should smoothly accelerate to a realistic speed, and then lift gently from the ground and climb at an angle consistent with that of the prototype. The take-off is completed after the model aircraft has turned 90 degrees.

If the prototype used flaps for take-off, then the model aircraft should also, but this may be subject to the competitor's judgement taking into account the wind strength. Any flapless take-off due to wind must be nominated to the judges before take-off. Flaps should be raised during the climb-out after take-off. If applicable, the landing gear should be retracted during the climb-out.

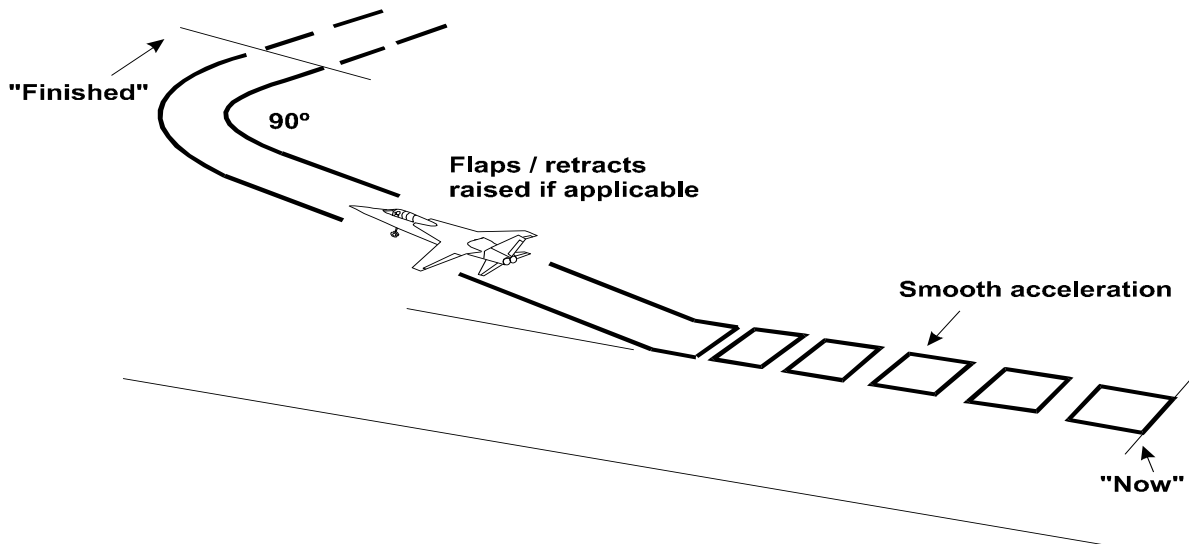
**Errors:**

1. Model aircraft touched after calling "Now" (zero marks).
2. Swings on Take-off (a slight swing with other than a tricycle undercarriage is acceptable as the aircraft tail is raised).
3. Take-off run too long or too short.
4. Unrealistic speed /too rapid acceleration.
5. Inappropriate attitude at lift-off for undercarriage configuration.
6. Not a smooth lift-off.
7. Climb rate wrong (too steep or too shallow).
8. Nose attitude wrong during climb (nose too high or too low).
9. Flaps not used if applicable.
10. Wheels not raised if applicable.
11. Significant wing drop.
12. Climb-out track not same as take-off run.
13. Unrealistic rate of turn onto crosswind leg.
14. Crosswind track not 90° to climb out track.

6C.3.6.2. Figure Eight

The model aircraft approaches in straight and level flight on a line parallel with the judges' line, and then a one-quarter circle turn is made in a direction away from the judges' line. This is followed by a 360-degree turn in the opposite direction, followed by a 270-degree turn in the first direction, completing the manoeuvre on the original approach line.

The intersection (mid point) of the manoeuvre shall be on a line that is at right angles to the direction of entry and passes through the centre of the judges' line.

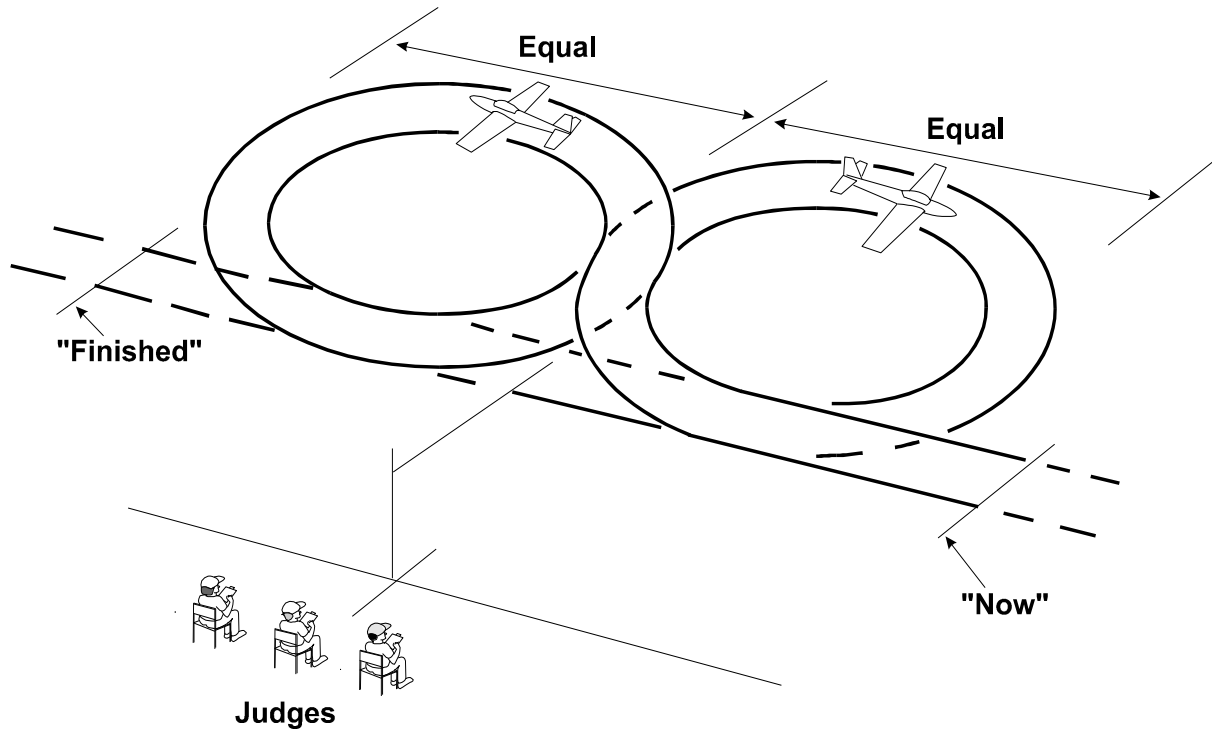
Errors:

1. Entry into first circle not at right angles to original flight path.
2. Circles unequal size.
3. Circles misshapen
4. Constant height not maintained.
5. Intersection not centred on judges' position.
6. Entry and exit paths not on same line.
7. Entry and exit paths not parallel with judges' line.
8. Overall size of manoeuvre not realistic for prototype.
9. Model aircraft flight path not smooth and steady.
10. Too far away/too close/too high/too low.

6C.3.6.3. 360° Descending Circle at Constant Low Throttle Setting:

Commencing from straight and level flight, the model aircraft performs a gentle 360° descending circle over the landing area, in a direction away from the judges, at a constant low throttle setting. The manoeuvre terminates at a maximum height of 6 metres, resuming straight and level flight on the same path.

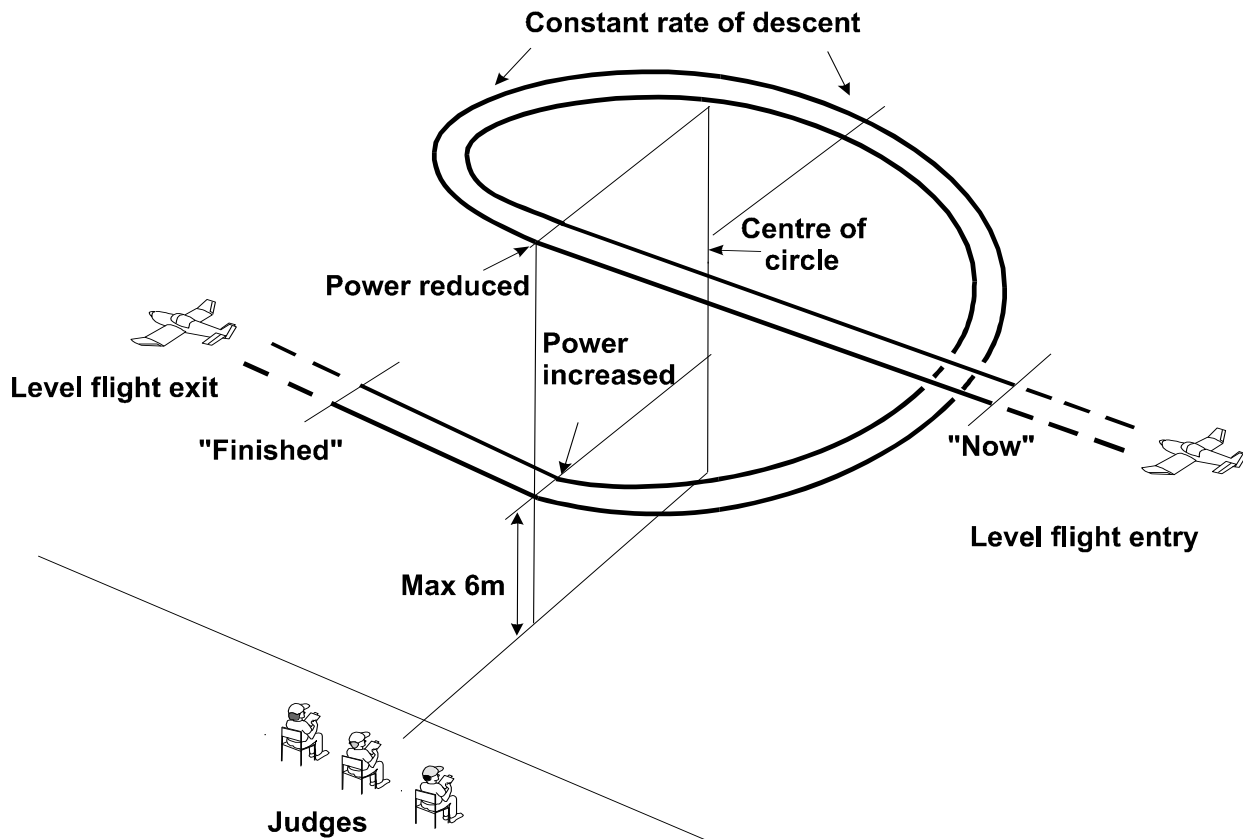

Errors:

1. Rate of descent not constant.
2. Descent too steep.
3. Throttle setting not constant or low enough.
4. Circle misshapen.
5. No significant loss of height.
6. Model aircraft does not descend to 6 metres or below.
7. Circle not centred on judges' position.
8. Entry and exit paths not parallel with the judges' line.
9. Start and finish not called in straight and level flight.
10. Too far away, too close.

6C.3.6.4. Optional manoeuvre, see 6C.3.7

6C.3.6.5. Optional manoeuvre, see 6C.3.7

6C.3.6.6. Optional manoeuvre, see 6C.3.7

6C.3.6.7. Optional manoeuvre, see 6C.3.7

6C.3.6.8. Optional manoeuvre, see 6C.3.7

6C.3.6.9. Optional manoeuvre, see 6C.3.7

6C.3.6.10 Approach and Landing

The manoeuvre commences by descending from base leg (in the same way as the Touch and Go). Prior to this point the model aircraft may complete any form of appropriate circuit to achieve a landing configuration. This may be a full rectangular or oval pattern, or a join directly onto the downwind or base legs. The Approach and Landing may be orientated into wind, or as required by the competitor to make best use of the landing distance available (eg jet subjects).

The base leg may be either straight or curved as required by the pilot. From the start position the model aircraft completes the turn through 90 degrees onto final approach. The model aircraft should round out smoothly, adopting the attitude applicable to the specific type and touch down without bouncing before smoothly rolling to a stop. An aircraft with conventional landing gear will make a three-point landing or will land on the main wheels and then gently lower the tail, as appropriate to the prototype, the prevailing wind conditions, or the surface of the landing area. An aircraft with tricycle landing gear will land on the main wheels first and then gently lower the nose wheel.

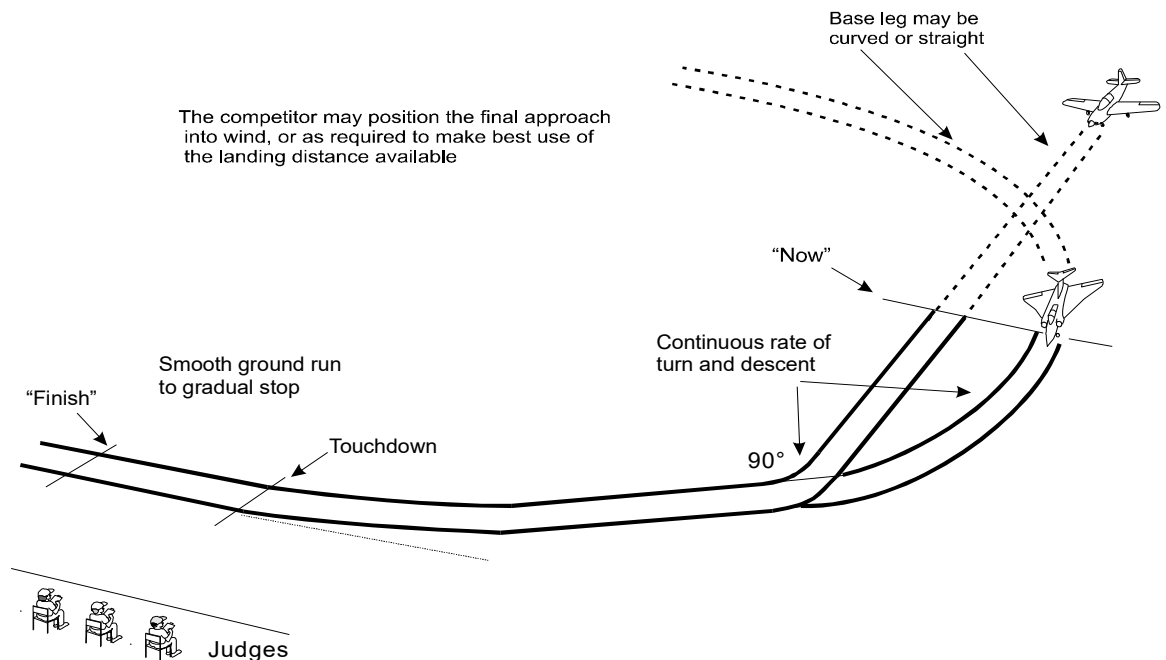

Errors:

1. Manoeuvre does not commence on base leg.
2. Turn onto final approach not constant rate or not 90°.
3. Descent from base leg not smooth and continuous.
4. Model aircraft does not achieve correct landing approach prior to touchdown.
5. Model aircraft does not round out smoothly.
6. Model aircraft bounces.
7. Drops a wing during landing.
8. Touches wing tip on ground.
9. Does not come to a gradual and smooth stop after landing.
10. Does not adopt landing attitude appropriate to subject type.
11. Model aircraft runs erratically or turns after landing.
12. Model aircraft noses over (note 2 points penalty if only nose-down; zero if it over-turns).

cont/...

Note: A crash landing scores zero points, but if the model aircraft makes a good landing and then stops nose down towards the end of the landing run, the landing marks that would have been otherwise awarded should be reduced by 2 points.

If the nose down situation is solely the result of the model aircraft running off the prepared area, because this is too short for the particular wind direction, the above down marking will not apply.

Model aircraft with retractable landing gears, landing with one or more gears retracted should have the landing points reduced by 30%.

All landings ending with the model aircraft on its back will be considered a crash landing.

6C.3.6.11. Realism in Flight

Realism in Flight covers the entire flight performance including the way in which the model aircraft flies between manoeuvres.

Judges will allot points for Realism within the following aspects, always keeping in mind the likely characteristics of the full size subject:

Model Sound K = 4

This is an assessment of how accurately the model replicates the characteristic sound of the full size aircraft. Judges should be familiar with typical sounds produced by different categories of aircraft and also be aware of the variations in sound produced at different speeds and varying throttle settings and/or propeller speeds. Judges should therefore consider how closely the sound produced by the model demonstrates what would be the typical sound produced by a full size aircraft in the same category and powered by a similar means of propulsion to that which the model is attempting to replicate.

There should also be some variation in the sound produced depending on throttle settings and whilst it is difficult, for example, to make a model powered by a single cylinder 2-stroke sound like a full size aircraft with a multi cylinder 4-stroke at full throttle, there may be times during the flight, particularly when the throttle is closed, when the sound is more realistic.

Special consideration should be given where the model demonstrates any particular characteristic sounds of the full size aircraft. Competitors are encouraged to advise judges if such characteristic sounds can be reproduced and where they will occur in the flight e.g. excessive propeller noise at high power setting or noise produced by the airframe during high 'g' manoeuvres.

Speed of the model aircraft K = 9

This should be a subjective assessment of the scale speed of the model aircraft, based on the speed of the full size aircraft (as indicated on the score sheet and documentation) judged as if it were performing a public flying display. Model aircraft invariably fly faster than scale speed and marks should be deducted accordingly. For example, a model aircraft that appears to be flying at twice scale speed should score no more than half marks, a model aircraft flying at three times scale speed, or faster, should score zero.

Smoothness of flight K = 9

The model aircraft should be well trimmed and show no signs of instability. Judges should assess the smoothness of control taking into account the prevailing weather conditions. They should also judge the attitude of the model aircraft in flight, i.e. any nose-up or nose-down tendency.

Realism in flight aspects shall be discussed by all flight judges after completion of the flight in consultation with any claim for non-aerobatic eligibility made on the Competitor's Declaration form (Annex 6C.1). The judges should attempt to arrive at an agreed score for this item.

Some original prototypes would have little or no aerobatic capability. These are aircraft designed with limited manoeuvrability where the original prototypes of which were restricted by the manufacturer or licensing government agency. Examples are touring aircraft, passenger and cargo aircraft and heavy military transports and bombers. The optional manoeuvres are included under 6.3.7. to cater for such subjects. These aircraft should still be considered for high marks in this section if the performance of the original prototype genuinely limits them to such manoeuvres. Conversely, if aircraft with greater manoeuvrability and performance choose these options when the original prototype would be capable of much more, then low marks should be awarded in this section.

cont/...

NOTES:

1. For any model aircraft that flies a manoeuvre with two or more wheels down, where the prototype actually featured retractable landing gear, the score shall be reduced by two points on that manoeuvre. If one wheel is down, the score shall be reduced by one point. If one or more wheels are only sagging during the manoeuvre, the score shall be reduced with one half or one point depending on the seriousness of the sagging.
2. If the pilot of the prototype is visible from the front or from the side during flight, a dummy pilot of scale size and shape shall be equally visible during flight in the model aircraft. If such a pilot is not fitted, the total flight score shall be reduced by 10%.

cont/...

6C.3.7. Optional Manoeuvres

The selection of optional manoeuvres should demonstrate the fullest possible capabilities of the aircraft subject type modelled.

The selection of manoeuvres and the order in which they are to be flown must be shown on the score sheet and given to the judges before each flight. This order must be adhered to and any manoeuvre flown out of sequence will score ZERO.

A. Chandelle:

From a straight and level flight the model aircraft passes the judges and then performs a 180° climbing turn in a direction away from the judges, resuming straight and level flight on the opposite heading. The rate of climb should be commensurate with that of the prototype.

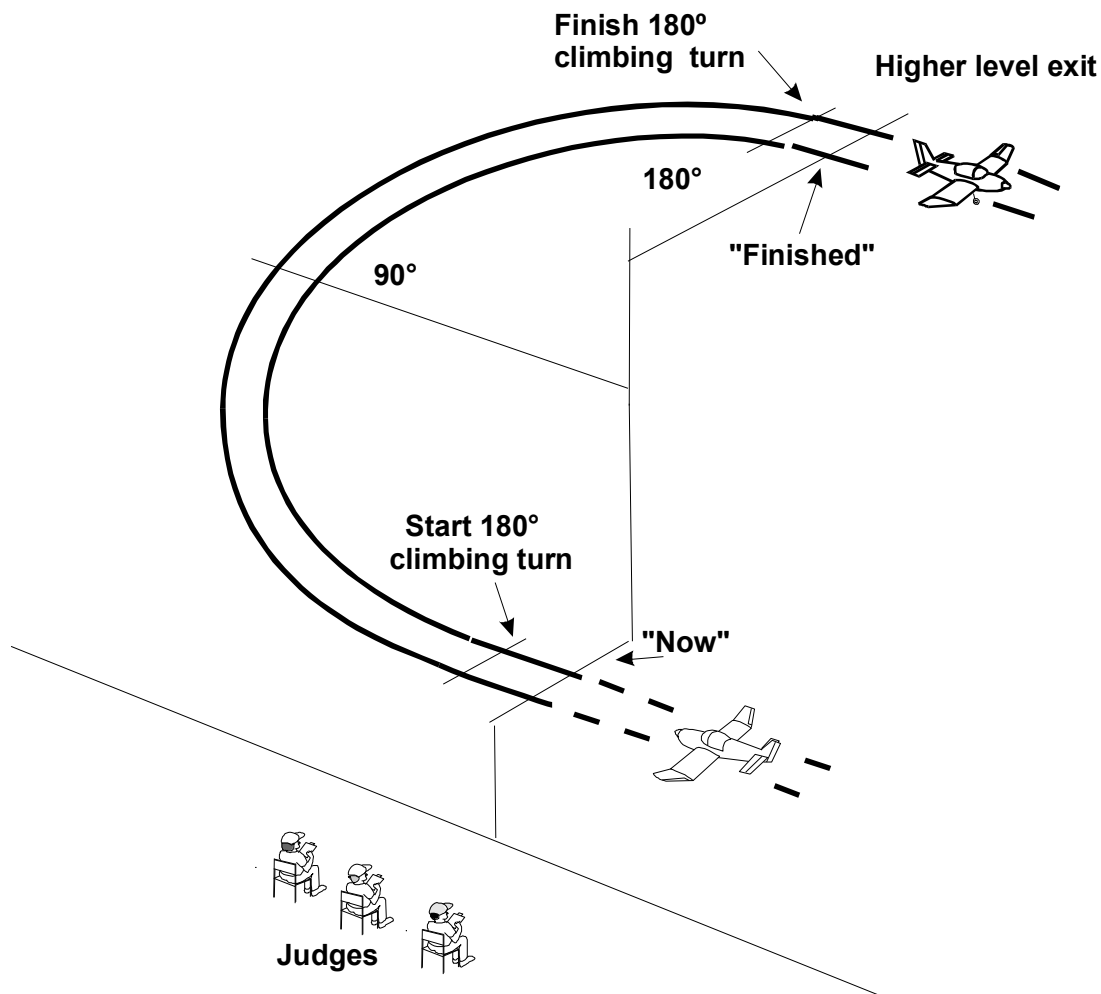
**Errors:**

1. Turn not smooth and continuous.
2. Climb not smooth and continuous.
3. Half height gain not at 90° position.
4. Excessive/unrealistic engine power used to achieve the climb.
5. Insignificant height gain.
6. Start and finish not centred on judges' position.
7. Entry and exit paths not parallel with the judges' line.
8. Final track not 180 degrees opposite to entry.
9. Entry and exit not in straight and level flight.
10. Too far away or too high.

B. Extend and Retract Landing Gear:

C. Extend and Retract Flaps: (Diagram and errors applicable to both manoeuvres unless stated)

Model aircraft approaches the landing area in straight and level flight at a height not exceeding 15 metres and in full view of the judges, extends the landing gear/flaps. Model aircraft then executes a 360° turn in a direction away from the judges, and when again directly in front of the judges retracts the landing gear/flaps and climbs away in straight flight.

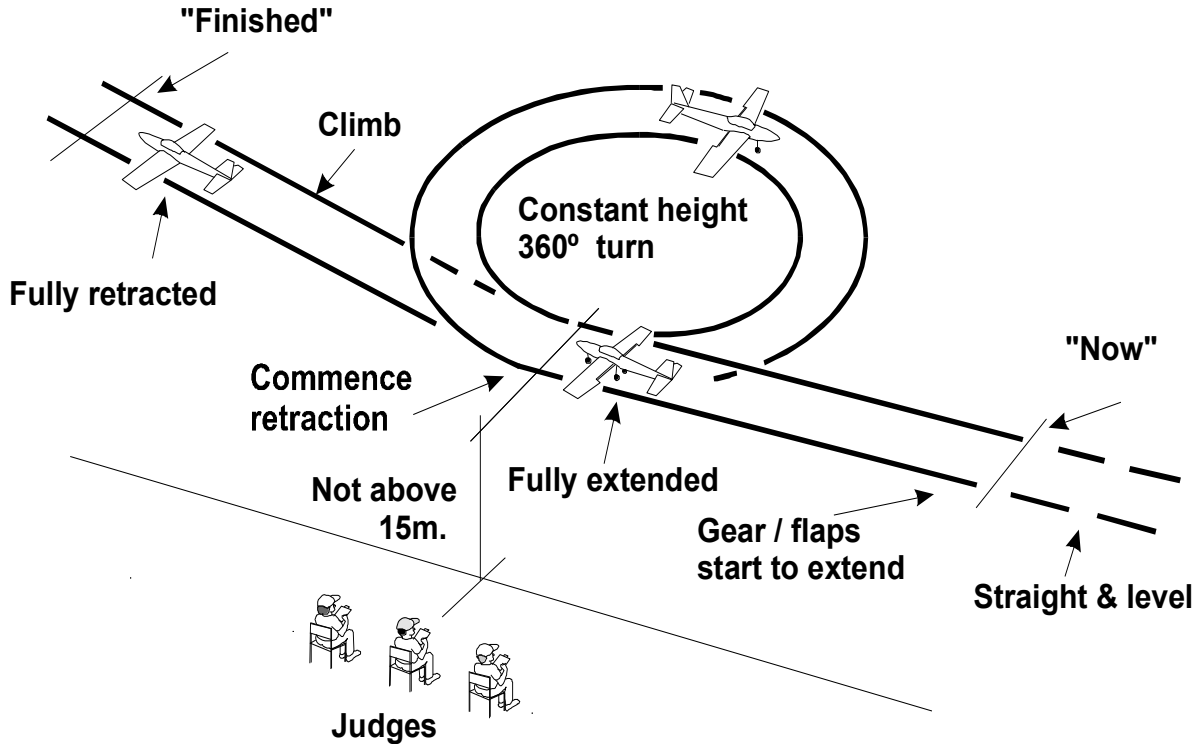

Errors:

1. Model aircraft speed too high for landing gear/flap lowering.
2. Gear/flaps not extended in full view of judges.
3. Speed and sequence of extension and retraction not realistic.
4. Flaps demo only:
 - a) Instability when flaps lowered,
 - b) No change in attitude with flaps.
5. Misshapen circle or not constant height.
6. Circle height exceeds 15 metres.
7. Circle not centred on judges' position.
8. Retraction not commenced abeam judges.
9. Entry and exit paths not parallel with the judges' line.
10. Entry and exit tracks not the same.
11. Un-scale-like climb out.
12. Too far away or too close.

D. Dropping of Bombs or Fuel Tanks:

If bombs are carried internally, bomb-bay doors must be open and be closed after the drop.

If bombs or fuel tanks are carried externally, they must be fitted in the correct positions and in the correct manner. Dropping should be in the manner of the prototype.

Dropping should be within clear view of the judges and centred on the judges' position.

Any special features of the manoeuvre should be declared to the judges beforehand.

Errors:

1. Bombs or tanks do not detach and fall in a realistic manner.
2. Drop is not in front of judges.
3. Overall dropping manoeuvre not presented in a realistic way.
4. Too far away/too close/too high/too low.

cont/...

E. Stall Turn:

The model aircraft starts in level flight, noses up to a vertical flight path until it comes to a stop. At which point the model aircraft yaws through 180 degrees, then dives and finally recovers straight and level on a flight path in the opposite direction to the entry. Entry and exit should be at the same height. The competitor should specify whether the turn shall be to the left or right. Low powered aircraft types would be expected to execute a shallow dive at full throttle in order to pick up the necessary speed before commencing the manoeuvre.

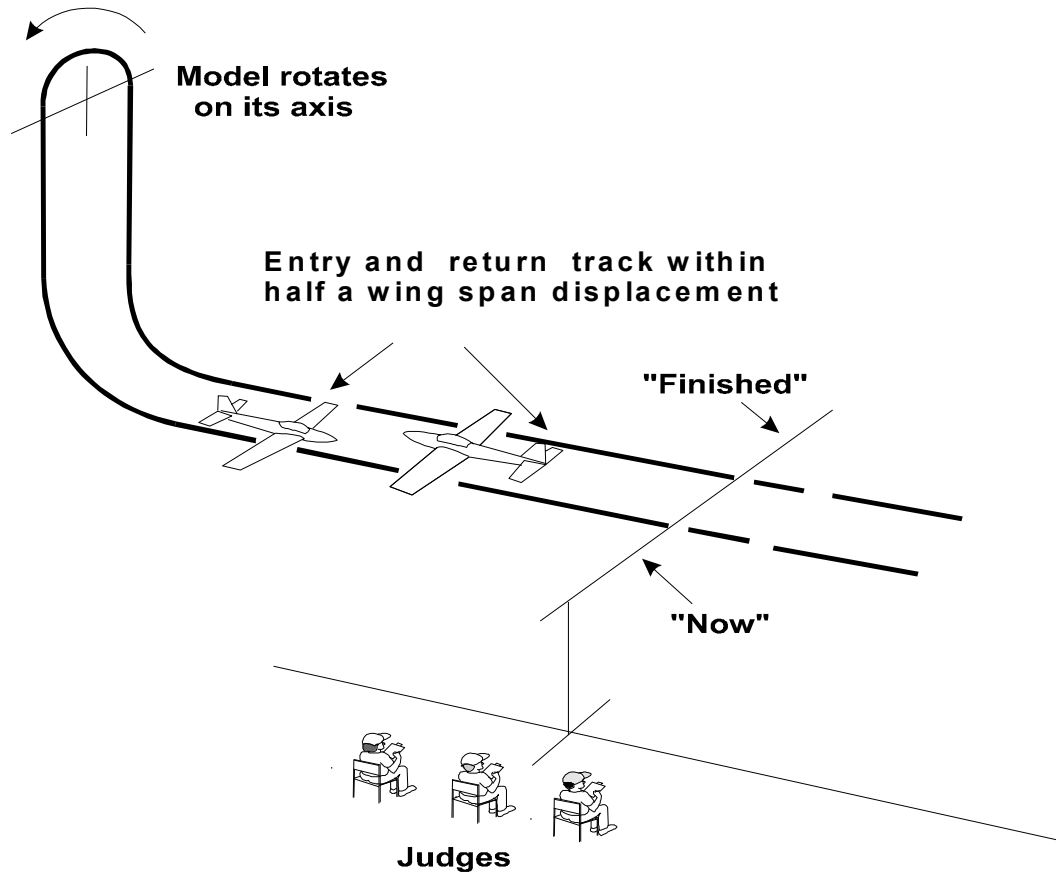
**Errors:**

1. Start and finish not parallel with judges' line.
2. Pull up not positioned to give best view to judges.
3. Climb and descent not near vertical.
4. Insufficient height gain.
5. Model aircraft does not stop.
6. Competitor does not specify or achieve nominated left/right turn.
7. Entry and exit paths are not at same height.
8. Model aircraft does not exit within half span displacement of entry track.
9. Entry and exit paths not parallel with the judges' line.
10. Too far away/too close/too high/too low.

F. Immelmann Turn:

From a straight and level flight the model aircraft pulls up into the first half of a circular loop (commensurate with the performance of the subject type), and when inverted, performs a half roll before resuming straight and level flight on the opposite track. Low powered aircraft types would be expected to commence the manoeuvre by executing a shallow dive at full throttle in order to pick up the necessary speed.

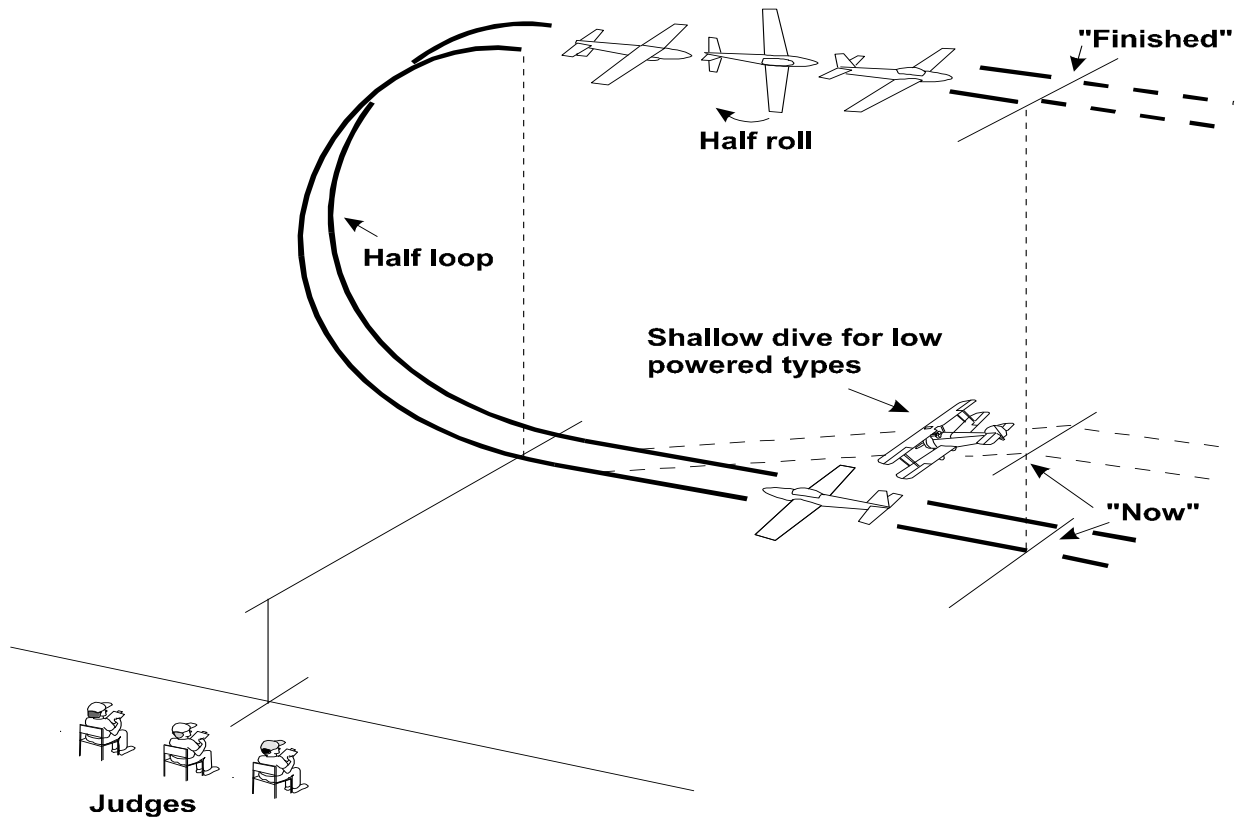
**Errors:**

1. Track of the half loop not vertical.
2. Half loop not centred on judges' position.
3. Half loop is not sufficiently semicircular.
4. Roll starts too early or too late.
5. Excessive height loss in the roll.
6. Track veers during the roll.
7. Does not resume straight and level flight on the opposite track to entry.
8. Manoeuvre not flown parallel with judges' line.
9. Size of manoeuvre and speed not in manner of the prototype.
10. Too far away/too close/too high/too low.

G. Loop:

From straight flight, the model aircraft pulls up into a circular loop and resumes straight and level flight on the same heading as the entry. The throttle may be reduced at the top of the loop as appropriate to type, and opened if necessary when normal flight is resumed. Low powered aircraft types would be expected to execute a shallow dive at full throttle in order to pick up speed before commencing the loop.

Note: Whilst the loop is intended to be a circular manoeuvre, the ability of a low powered aircraft to achieve a perfect circle will be significantly less than that of a jet or high powered aerobatics machine. A slightly elongated loop by the former would therefore expect to score as well as a perfect circle achieved by the latter, but a grossly misshapen circle would be significantly down marked. This also applies to other options involving looping manoeuvres.

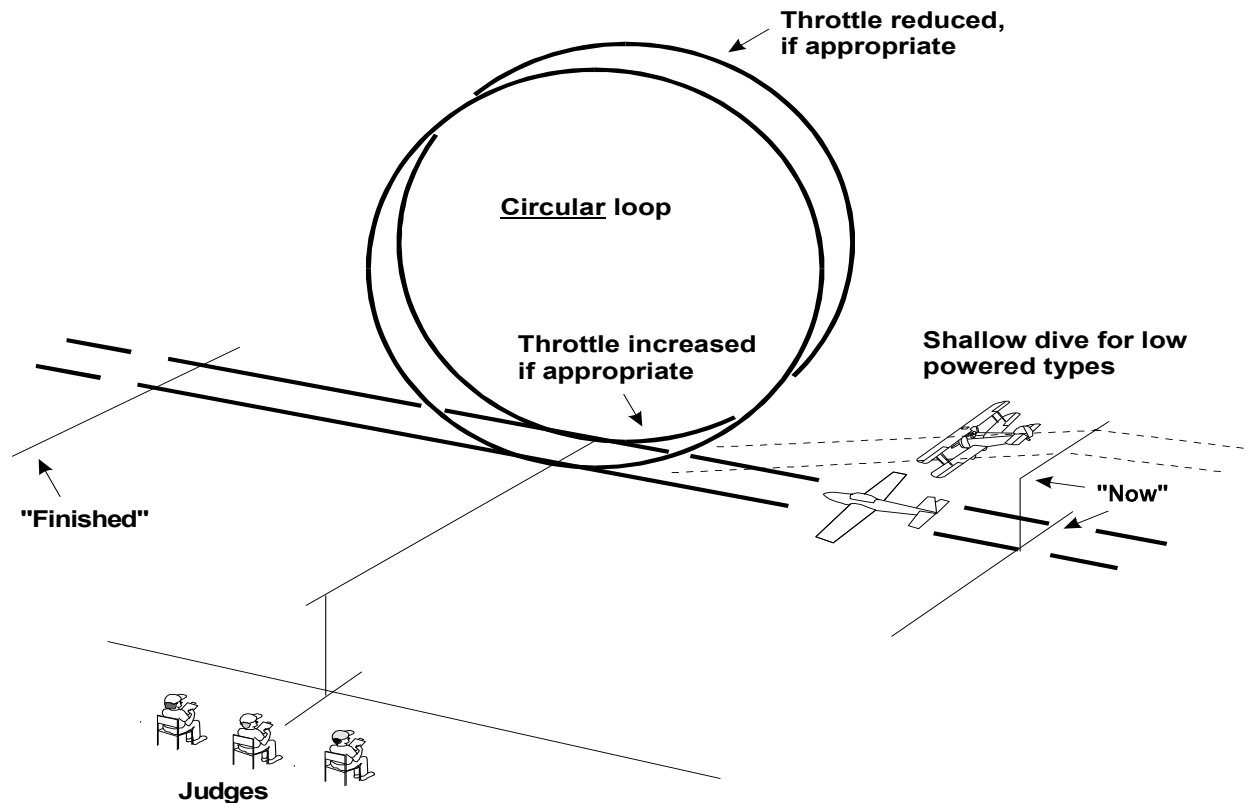
**Errors:**

1. Track of loop not vertical
2. Loop not sufficiently circular, commensurate with the subject type.
3. Inappropriate use of throttle.
4. Size and speed of Loop not in manner of prototype.
5. Not centred on judges' position.
6. Does not resume straight and level flight on same track and height as entry.
7. Manoeuvre not flown parallel with judges' line.
8. Too far away/too close/too high/too low.

H. Cuban Eight:

Model aircraft pulls up into a circular inside loop until 45° nose down. The 45° inverted flight is held until a half roll when abeam the judges, 45° upright then held until entry height is achieved when a similar circular inside loop is flown to repeat the manoeuvre in the opposite direction. Straight and level recovery is to be at the same height as the original entry. Throttle may be closed at the top of each loop, as appropriate to subject type, and reopened during each descent. A low powered aircraft would be expected to execute a shallow dive at full throttle in order to pick up speed before commencing the manoeuvre.

Included in this manoeuvre are the following deviations based on the primary Cuban Eight:

“Half Cuban Eight”

After the first 45 degree dive, the model pulls out level at the entry height.

“Reversed Cuban Eight”

The model aircraft starts with a pull up 45° climb with half roll then enters the loop and continues as above but in reverse order.

“Reversed Half Cuban Eight”

Start with the 45° climb and half roll then loop to finish level with entry.

Competitor must specify on the score sheet which variation will be used.

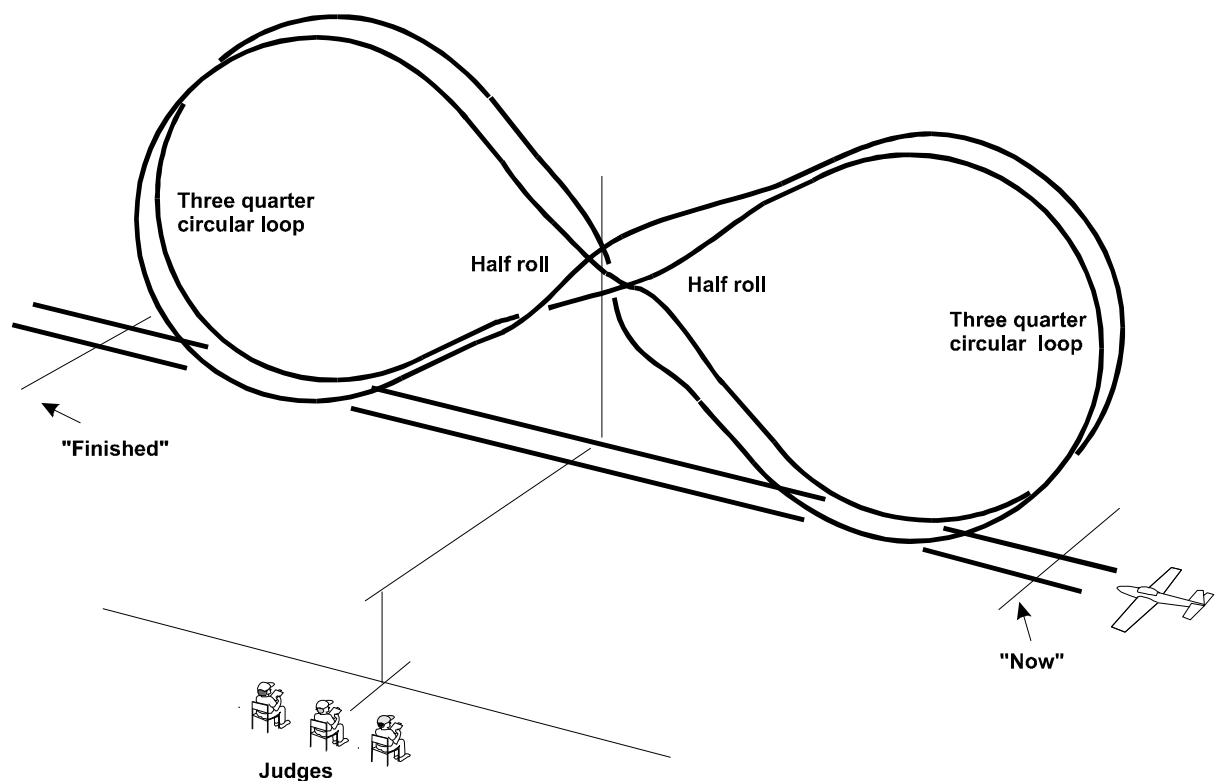

Errors:

1. Manoeuvre not performed in a constant vertical plane that is parallel with the judges' line.
2. Loops are not circular.
3. Loops are not the same size.
4. Half rolls are not centred on the judges' position.
5. 45° descent paths not achieved.
6. Model aircraft does not exit manoeuvre at same height as entry.
7. Model aircraft does not resume straight and level flight on same track as entry.
8. Inappropriate use of throttle.
9. Size and speed of loops not in manner of prototype.
10. Too far away/too close/too high/too low.

I. Split S (Reversal):

From straight flight, the model aircraft performs a half roll and when inverted performs half of a circular inside loop (commensurate with the performance of subject type), and resumes straight and level flight on a flight path opposite to that of the entry. The throttle should be closed at the inverted position, as appropriate to type, and opened when normal flight is resumed.

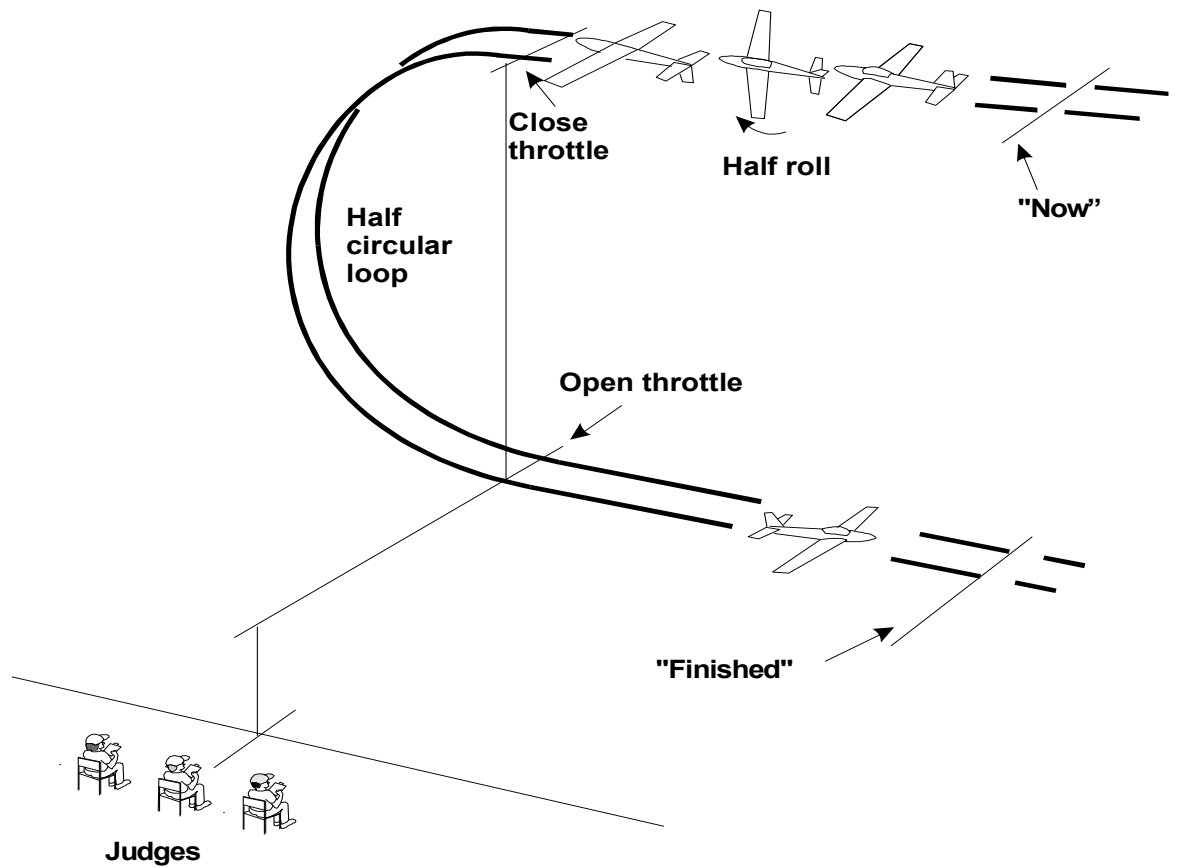
**Errors:**

1. Model aircraft changes track during half roll.
2. Model aircraft inverted too long or too short.
3. Inappropriate use of throttle.
4. Track of half loop not on line or vertical.
5. Half loop is not sufficiently semicircular.
- 6 Too fast or too tight a half loop.
7. Does not resume straight and level flight on opposite track to entry.
8. Half loop not centred on judges' position.
9. Manoeuvre not flown parallel with the judges' line.
10. Too far away/too close/too high/too low.

J. Spin Three Turns:

From straight and level flight, the model aircraft decelerates into a stall and commences the spin through three turns and recovers to level flight on the same track as the initial flight direction. During descent the model aircraft may drift with the wind.

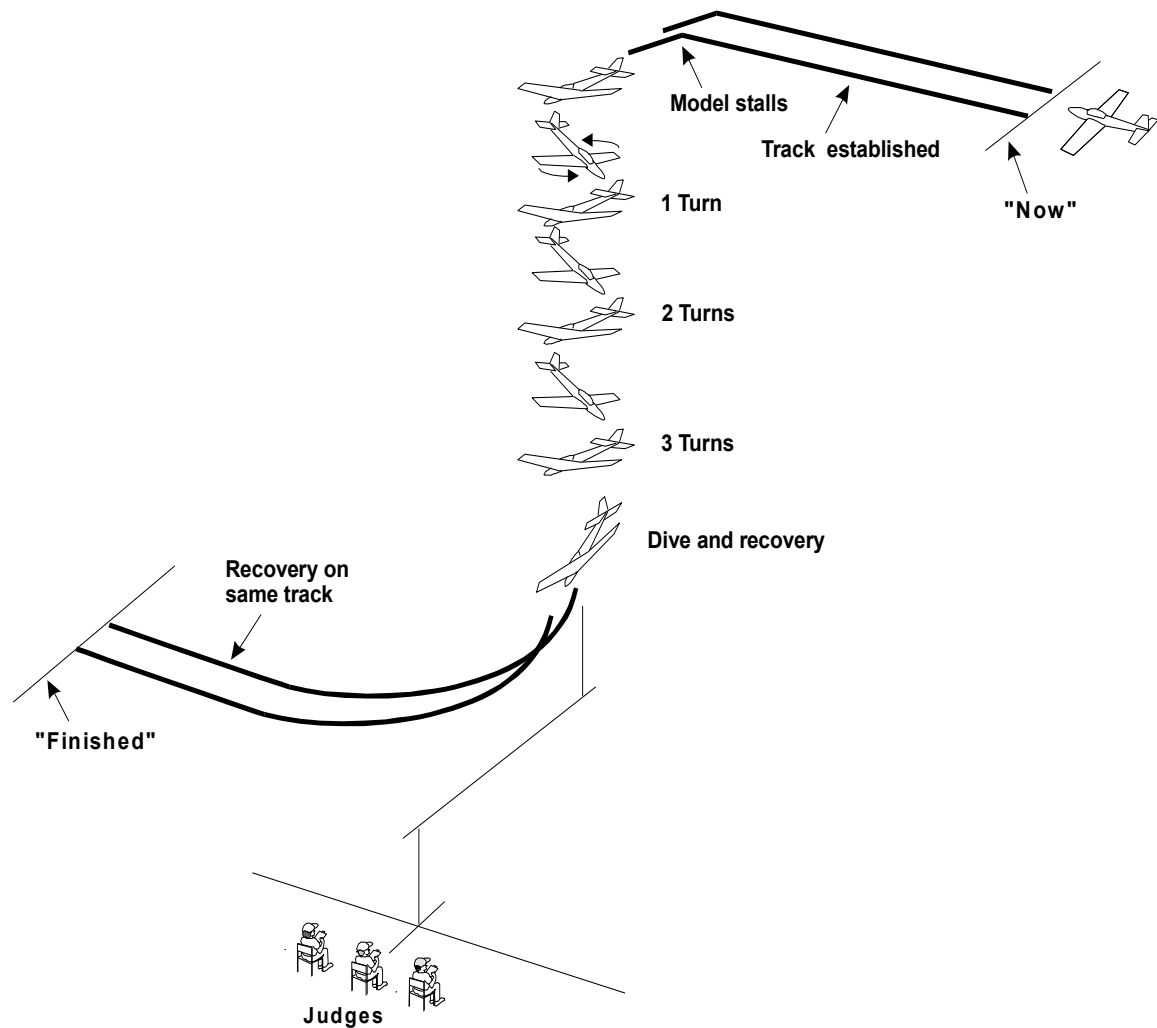
**Errors:**

1. Engine not throttled back at point of stall.
2. Entry into spin not clean and positive.
3. Not a true spin but merely a spiral dive (which should score zero).
Note In a true spin descent path will be close to C of G of model aircraft. A spiral dive is a tight vertical barrel roll.
4. Not three complete turns.
5. Start of spin not centred on judges' position.
6. Model aircraft does not resume straight and level flight on same track as entry.
7. Entry and exit paths not parallel with judges' line.
8. Entry and exit not in level flight
9. Too far away/too close/too high/too low.

K Roll:

From straight and level flight, the model aircraft rolls at a constant rate through one complete rotation and resumes straight and level flight on the same track. Low powered aircraft would be expected to execute a shallow dive at full throttle before the manoeuvre. Competitors should nominate any special type of roll that will be performed, eg Slow, Barrel, Snap.

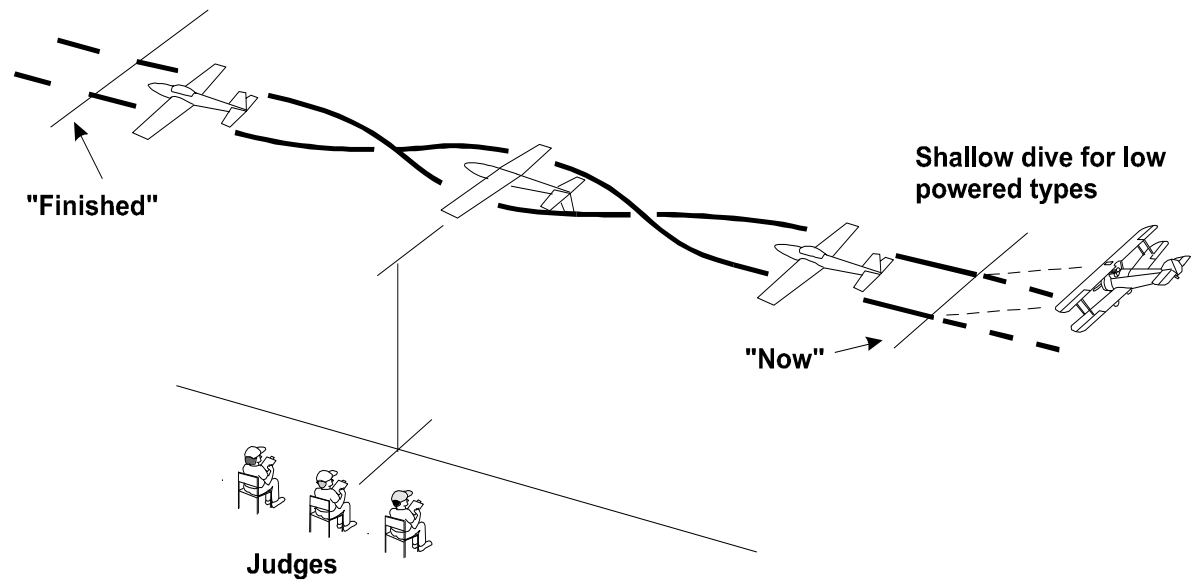
**Errors:**

1. Rate of roll is not constant.
2. Style of roll not typical to prototype.
3. Roll not centred on judges' position.
4. Entry and exit at different heights.
5. Entry and exit at different speeds.
6. Entry and exit tracks and line of roll not parallel with judges' line.
7. Does not resume straight and level flight on same track as entry.
8. Style of roll not as nominated.
9. Inappropriate use of throttle.
10. Too far away/too close/too high/too low.

L Parachute:

The drop should be in the manner of the prototype. For example, cargo should be dropped from a hatch or bomb bays. Man via doors, hatch or by inverting the aircraft. The model aircraft should reduce speed before commencing drop, possibly by using flaps and lowering the landing gear. If the prototype used a braking parachute in landing, the competitor may demonstrate this.

M Touch and Go:

The model aircraft commences by descending from base leg, which may be either curved or straight as required by the pilot. The turn is continued through 90 degrees onto final approach. The model aircraft then lands and takes off again into wind without coming to a halt. The main wheels must roll on the ground for a minimum of five metres. Flaps will be used if applicable.

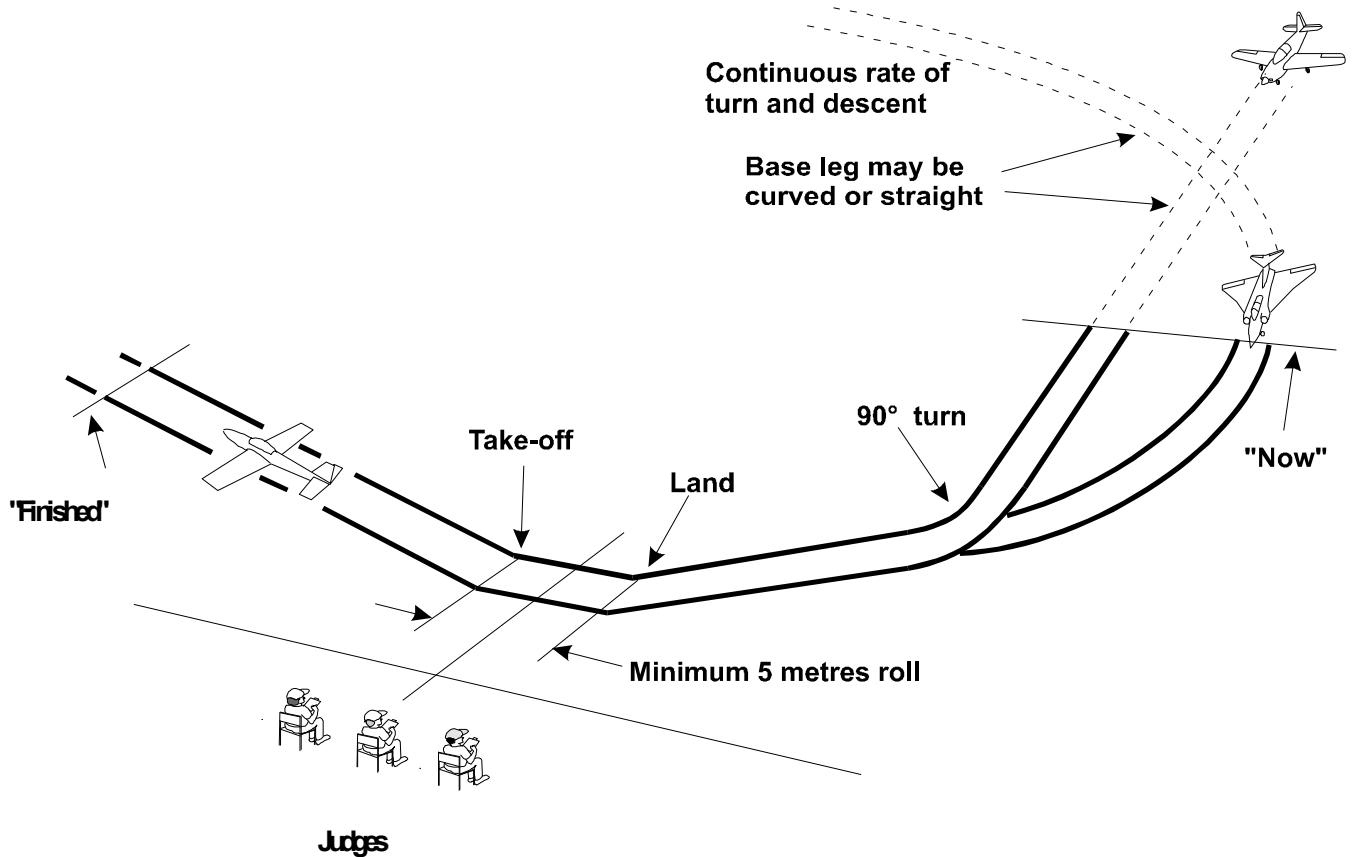
**Errors:**

1. Manoeuvre does not commence on base leg.
2. Turn onto final approach too tight or not 90°.
3. Descent from base leg not smooth and continuous.
4. Model aircraft does not achieve correct landing approach prior to touchdown.
5. Model aircraft does not achieve a minimum ground roll of 5 metres.
Note: if prototype has two main wheels then both wheels must roll on ground for a minimum 5 metres.
6. Model aircraft bounces on landing.
7. Inappropriate use of flaps.
8. Climb out not smooth or realistic.
9. Approach and climb out tracks not the same.
10. Does not make best use of landing space available for wind direction.

N Overshoot:

The model aircraft commences by descending from base leg, which may be either curved or straight as required by the pilot. The turn is continued through 90 degrees onto a higher than normal landing approach on low throttle, using flaps if applicable. On reaching the centre of the landing area at a height of approximately 3 metres, power is applied to check the descent. After normal flying speed and attitude are attained the model aircraft climbs straight ahead. The aim of the manoeuvre is to simulate an aborted landing due to a higher than normal landing approach.

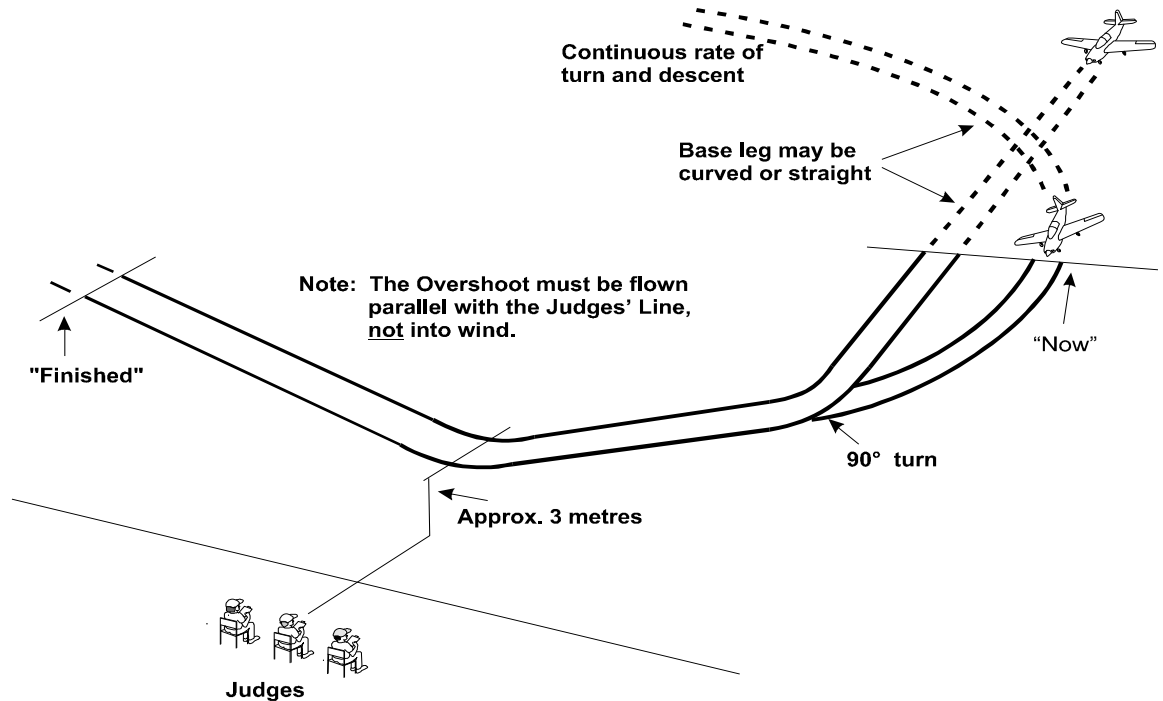
**Errors:**

1. Manoeuvre does not commence on base leg.
2. Turn onto final approach not smooth and continuous or not 90°.
3. Model aircraft does not achieve correct high landing approach.
4. Model aircraft does not achieve correct landing speed or attitude.
5. Not continually descending until power applied.
6. Model aircraft descends to significantly above or below 3 metres.
7. Lowest point of manoeuvre not achieved in front of judges.
8. Not smooth transition of speed & attitude from approach, through descent check to climb-out.
9. Inappropriate use of flap and/or gear.
10. Model aircraft could have landed from approach.
11. Model aircraft does not climb away smoothly.
12. Approach and climb out tracks not the same.
13. Too close or too far away.

O Side Slip:

The model aircraft commences the manoeuvre in level flight by reducing power on base leg, and then turns onto a higher than normal final approach that is parallel with the judges' line. As the model aircraft enters the turn it starts a Sideslip by the application of opposite rudder to the direction of turn, achieving a yaw of at least 20° off track. A marked loss of height must be apparent whilst maintaining final approach speed. The aim of the Sideslip, if continued, would be to effect a landing in front of the judges. Before reaching the judges' position however, the Sideslip is corrected, normal flight is resumed and the model aircraft carries out an overshoot from below 5 metres before climbing away. The purpose of this manoeuvre is to demonstrate a marked loss of height on final approach without an excessive build up of speed or the use of flap.

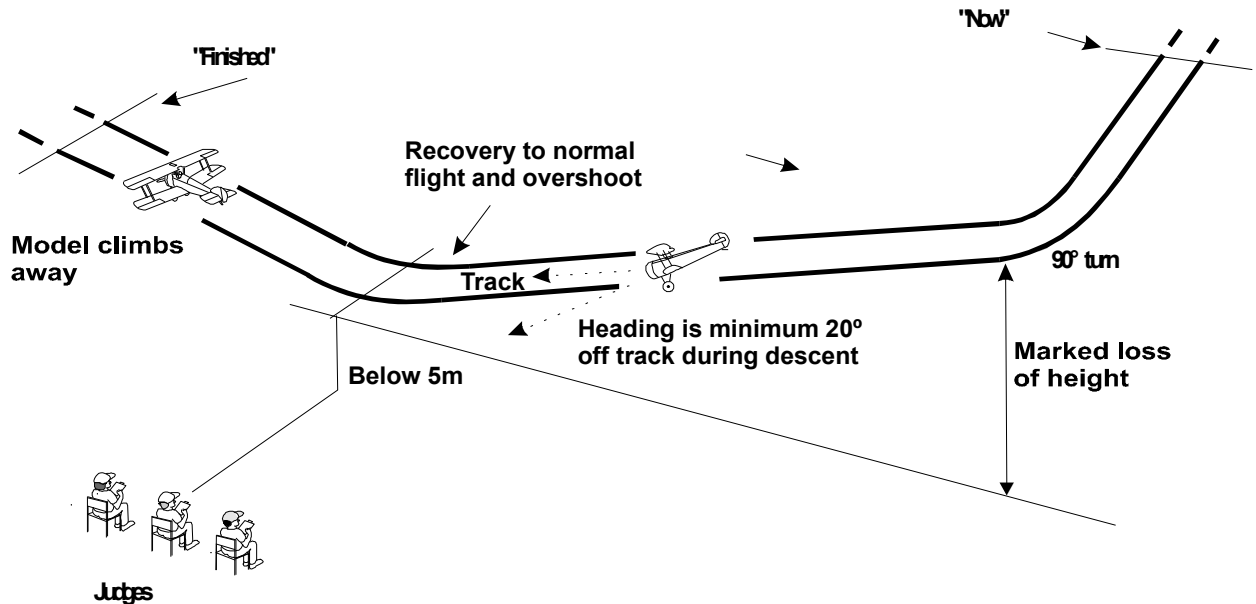

Errors

1. Model aircraft does not smoothly enter Sideslip upon turning final approach.
2. Model aircraft is not yawed at least 20° off track during Sideslip.
3. Rate of Sideslip and descent are not constant.
4. There is insufficient height loss.
5. Excessive speed is built up during descent.
6. Approach track not maintained or not flown parallel with judges' line.
7. The Sideslip is not corrected before passing the judges.
8. Overshoot is not below 5 metres.
9. Not a smooth transition during return to normal flight and climb-out.
10. Too far away/too close/too high/too low.

P and Q. Flight Function(s) Performed by Prototype Aircraft:

A competitor may demonstrate up to two different flight functions of his own choice but must indicate to the flight judges the nature of the demonstration(s) before going to the flight line. The competitor must be prepared to supply evidence that the aircraft performed this function subject type modelled, eg crop spraying, outside loop etc.

Procedural flying manoeuvres such as procedure turn, climbing turn, descending turn, etc are not acceptable. Mechanical options, which could be equally performed on the ground (eg switching on and off lights), are also not allowed.

R. Flight in Triangular Circuit:

The model aircraft approaches in a straight and level flight to a point directly in front of the judges. It then turns away to track 60° away from the judges' line. It then flies straight and level for a minimum of 150 metres, turns to track parallel with the judges' line, flies a further minimum of 150 metres, then turns to track towards the judges and flies a further minimum of 150 metres to a position above the centre of the landing area, which completes an equilateral triangle (i.e. a triangle with sides of equal length and angles of 60°), before making a final turn to intercept the original entry track.

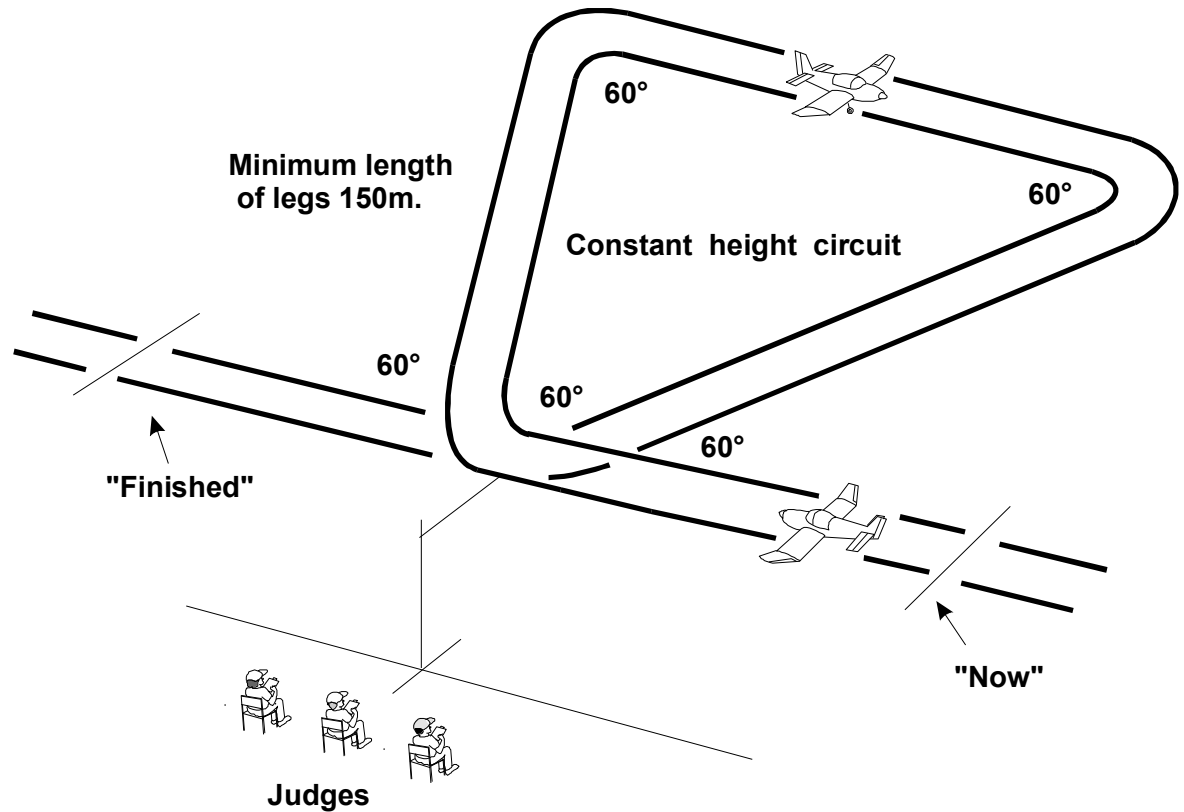
**Errors:**

1. Not commenced and finished at points equidistant from the judges.
2. Model aircraft changes height.
3. Rate of turn at corners not constant or inside corners of triangle not 60° .
4. Sides of the triangle are not straight.
5. Sides of triangle are not equal lengths.
6. Sides of the triangle are too long or too short.
7. Apex of triangle not centred on judges' position.
8. Correction for drift not properly made.
9. Start and finish tracks not the same.
10. Start and finish tracks not parallel with judges' line.
11. Too far away/too close/too high/too low.

S Flight in Rectangular Circuit:

The model aircraft approaches in straight level flight to a point directly in front of the judges. It then continues for a minimum of 75 metres before it turns away to track 90° from the judges' line and flies straight and level for a minimum of 150 metres before turning to track parallel with the judges' line for a further minimum of 75 metres. It then turns to track directly towards the judges for a minimum of 150 metres, to a point in front of the judges, before completing a final turn to intercept the original entry track. This manoeuvre describes a rectangle over the ground.

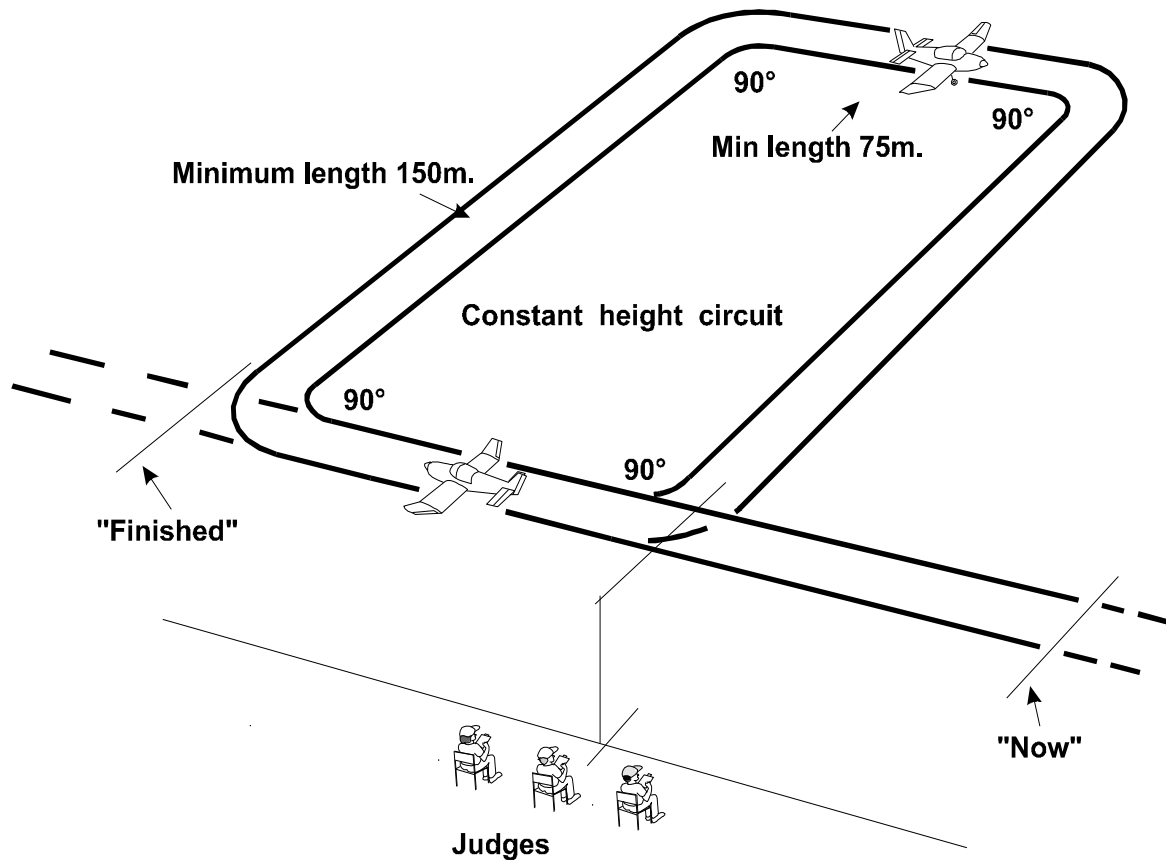
**Errors:**

1. Not commenced and finished at points equidistant from the judges.
2. Model aircraft changes height.
3. Rate of turn at corners not constant or corners not 90°.
4. Legs are not straight.
5. Legs too long or too short.
6. Opposite sides of rectangle are not of equal length
7. Correction for drift not properly made.
8. Final leg of rectangle not centred on judges' position.
9. Start and finish tracks not the same.
10. Start and finish tracks not parallel with judges' line.
11. Too far away/too close/too high/too low.

T Flight in a Straight Line at Constant Height (Maximum 6 m):

Model aircraft approaches in straight flight at a constant height not exceeding 6 metres for a minimum distance of 100 metres, then climbs away. This is in effect a low flypast.

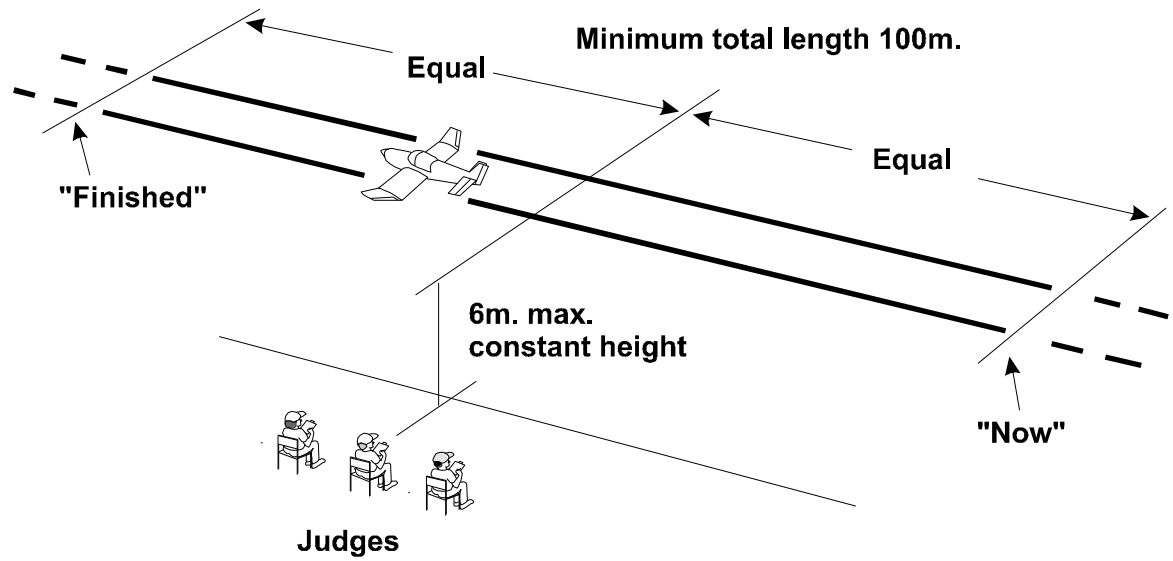

Errors:

1. Not a straight course (slight corrections acceptable with light aircraft).
2. Not constant height.
3. Not 6 metres or below.
4. Not pass over the landing area.
5. Not centred on judges' position.
6. Not parallel with the judges' line.
7. Too short distance (too long is not an error).
8. Model aircraft flight path not steady.
9. Too far away/too close/too high/too low.

U Flight in a Straight Line With One Engine Throttled:

Model aircraft approaches in straight flight at a constant height with one engine throttled, for a minimum of 100 metres, after which the engine is opened up and the model aircraft resumes normal flight. (This option is only for multi-engined subjects.)

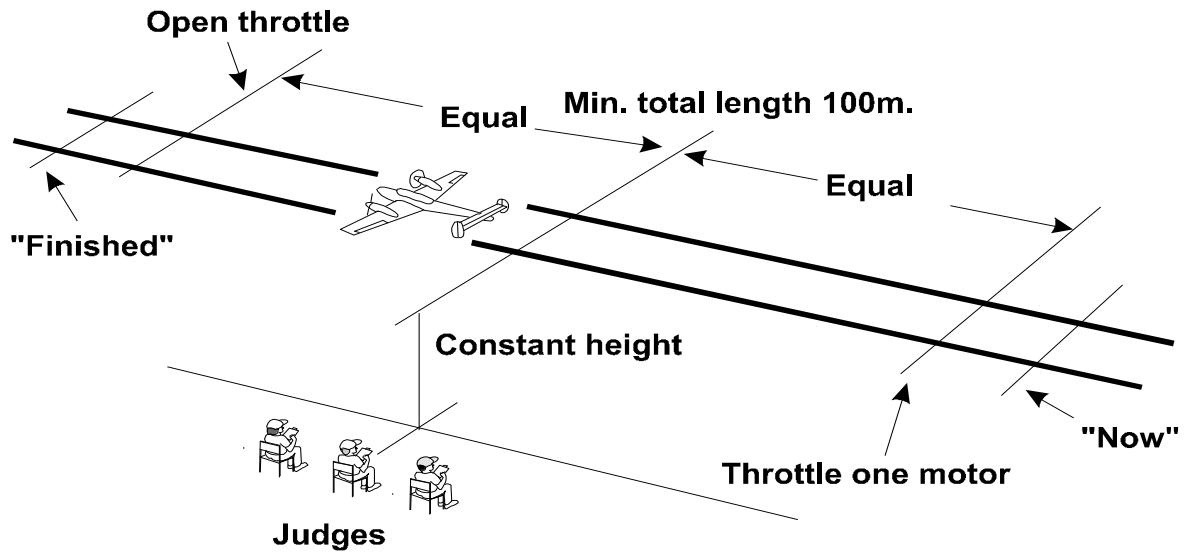

Errors:

1. Flight not straight.
2. Model aircraft is unstable.
3. Undue loss of height.
4. Engine not opened up after demo.
5. Engine not throttled back sufficiently.
6. Insufficient duration.
7. Not centred in front of judges' position.
8. Not flown parallel with the judges' line
9. Too far away/too close/too high/too low.

V Lazy Eight

The model aircraft approaches in straight and level flight on a line parallel with the Judges' line. When the model aircraft is in line with the judges (the centre) a smooth curving climb is commenced which progresses to a smooth climbing turn of constant radius away from the judges. At the apex of the turn the bank should be at least 60° and the model aircraft shall be on a heading of 90° to the judges' line. The nose of the model aircraft then lowers and the bank comes off at the same rate as it went on. The turn is continued beyond 180° to intercept the centre with the wings level and at the same height as the entry height into the manoeuvre.

At the centre another smooth climbing turn, the shape of which should be the same as the first turn, is immediately commenced away from the judges,. The second turn is then continued beyond 180° to cross the centre with the wings level and at the same height as the entry into the manoeuvre. The Lazy Eight is completed by maintaining this height and heading with wings level before turning to intercept the original approach track to exit the manoeuvre parallel to the judges' line in straight and level flight. A low powered aircraft would be expected to execute a shallow dive at full throttle in order to pick up speed before commencing the manoeuvre. The figure should be symmetrical each side of the judges' position.

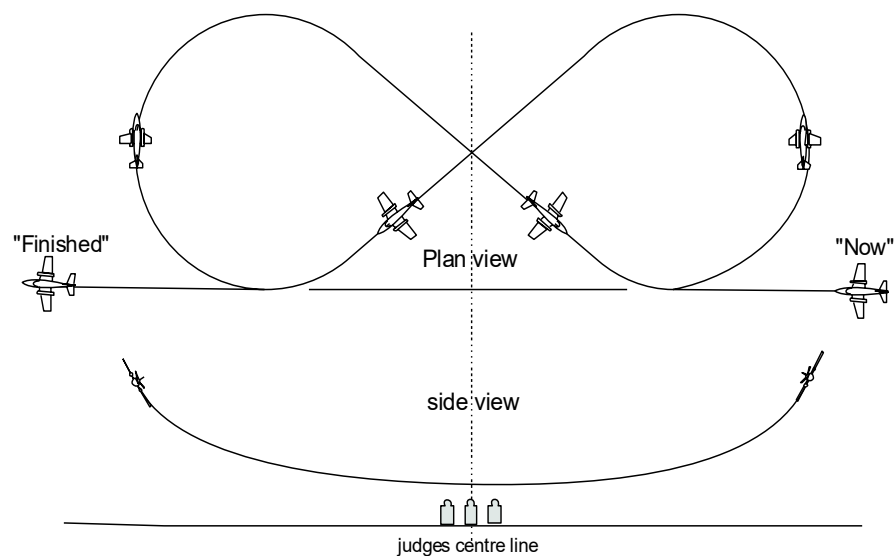

Errors:

- 1 Entry and exit paths not parallel with judges' line.
2. Insufficient climb achieved.
- 3 Insufficient bank achieved.
- 4 Climb and descent angles not equal throughout manoeuvre.
5. Manoeuvre not symmetrical about judges' position.
6. Arcs misshapen.
7. Start and finish positions not as indicated.
8. Overall size of manoeuvre not realistic for prototype.
9. Model aircraft flight path not smooth and steady.
- 10 Too far away/too close/too high/too low.

W Wingover.

The model aircraft approaches in straight and level flight on a line parallel with the Judges' line. After passing the judges' position a smooth climbing turn is commenced away from the judges. At the apex of the turn, the model should track 90° to the entry track and the bank angle should be appropriate to the capability of the prototype, but usually no more than 60° for a non-aerobatic model and at least 60° for an aerobatic model. The height gain should be appropriate to the capability of the prototype. The model then continues on a mirror image of the entry flight path and recovers to straight and level flight at the same height but on the opposite heading to the entry and on a line displaced away from the judges.

A low powered aircraft would be expected to execute a shallow dive at full throttle in order to pick up speed before commencing the manoeuvre.

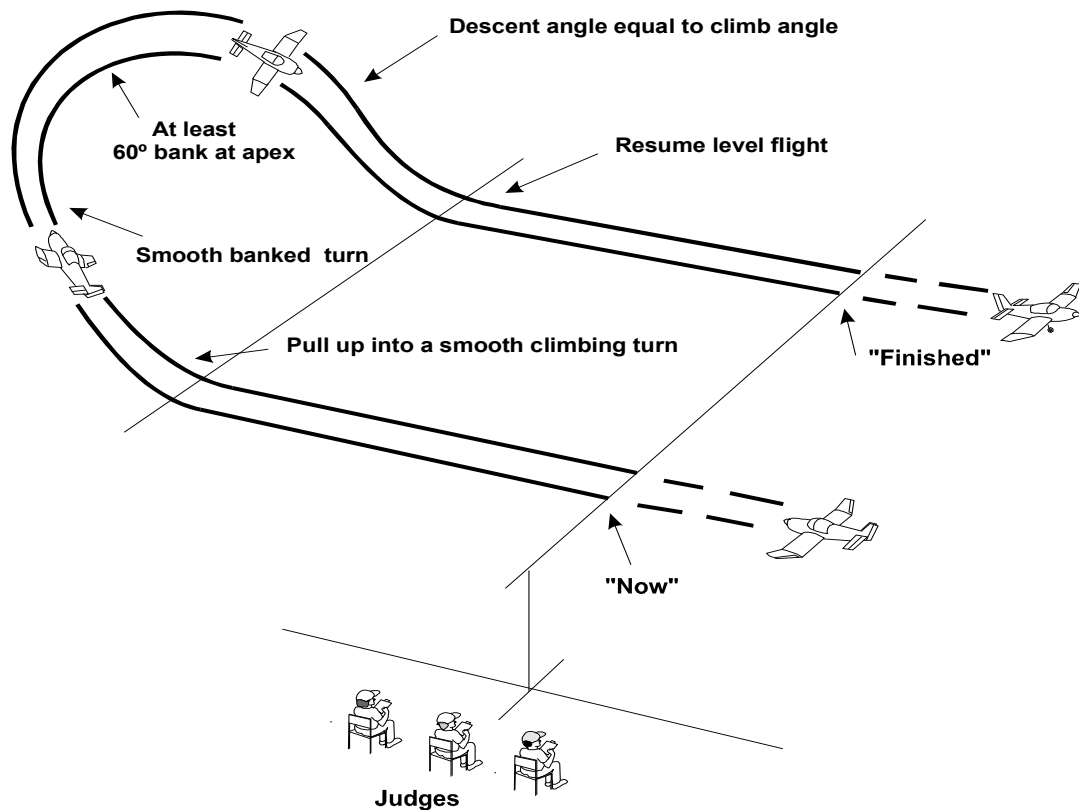
**Errors:**

1. Start and finish positions not as indicated.
2. Insufficient climb achieved.
3. Insufficient bank achieved
4. Climb and descent angles not equal throughout manoeuvre.
5. Model aircraft does not fly a smooth and symmetrical arc.
6. Entry and exit paths not parallel with judges' line.
7. Overall size of manoeuvre not realistic for prototype.
8. Model aircraft flight path not smooth and steady.
9. Too far away/too close/too high/too low.

X Inverted Flight.

Model aircraft half rolls into inverted attitude and makes a straight inverted flight of 100 metres in length, and then half rolls out of inverted attitude and resumes normal straight flight. A low powered aircraft would be expected to execute a shallow dive at full throttle in order to pick up speed before commencing the manoeuvre.

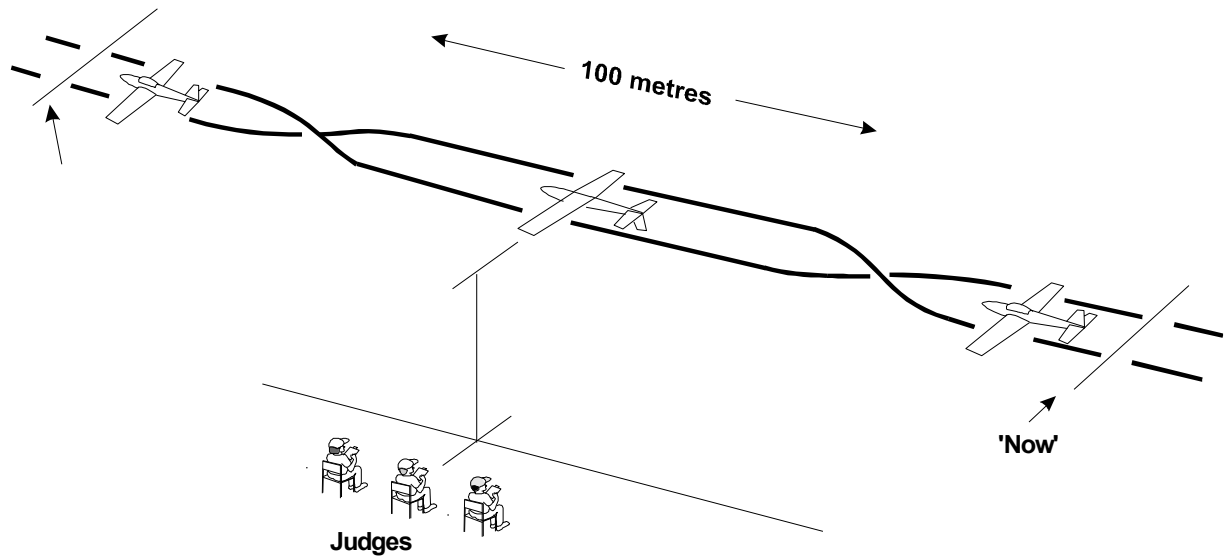
**Errors:**

1. Half rolls not performed on same track as inverted flight.
2. Model aircraft does not fly a straight course.
3. Model aircraft gains or loses height.
4. Model aircraft does not remain inverted for the prescribed duration.
5. Manoeuvre not centred on judges' position.
6. Manoeuvre not flown parallel with judges' line.
7. Too far away/too close/too high/too low.

Y. Derry Turn

The model approaches at a high speed in straight and level flight on a line parallel with the judge's line. The model aircraft then makes a steep (in excess of 60° bank) one quarter circle turn in a direction away from the judges, without losing height. When centred in front of the judges the model aircraft makes a half roll in the same rolling direction as the entry, again directly followed by a steep one quarter circle turn in the opposite direction, and then flies off straight and level on a line parallel with that of the entry to the manoeuvre. The manoeuvre should be smooth and continuous.

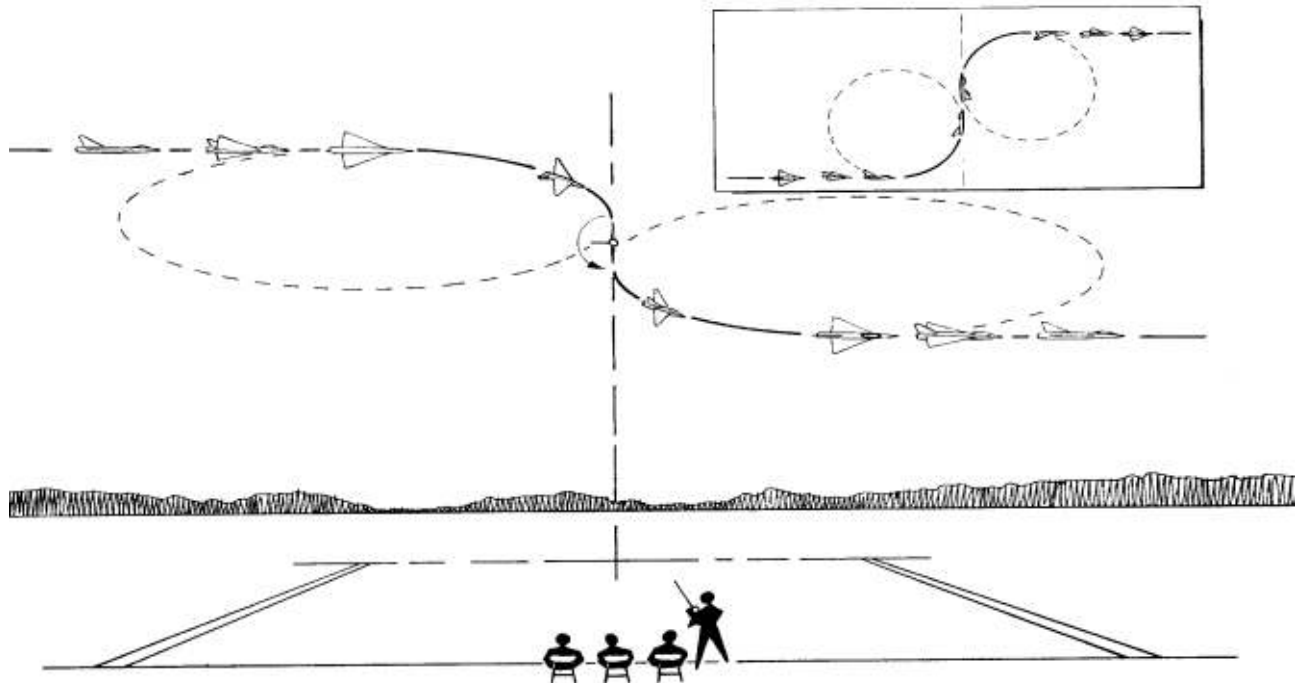

Errors

- 1) Entry not in parallel with the judges' line.
- 2) The manoeuvre not centred in front of the judges.
- 3) The rolling manoeuvre in front of the judges not axial.
- 4) The roll in centre not in the same direction as the entry to the manoeuvre.
- 5) The roll not carried out on a line directly away from the judges.
- 6) Any hesitation between the end of the first quarter turn, the roll and/or the start of the second turn.
- 7) Exit not parallel with entry.
- 8) Significant height difference during the manoeuvre.
- 9) The manoeuvre misshapen as seen as part of a figure eight.
- 10) The manoeuvre is executed too low or too high to be easily judged.

Z. Procedure Turn

Commencing from straight and level flight the model aircraft must turn through 90° in a direction away from the judges and then turn through 270° in the opposite direction, resuming straight and level flight on the opposite heading to that of the entry. The manoeuvre must be commenced so as to place the point where the model aircraft changes from the 90° turn to the 270° on a line which is at a right angle to the direction of entry and passes through the centre of the judges' position.

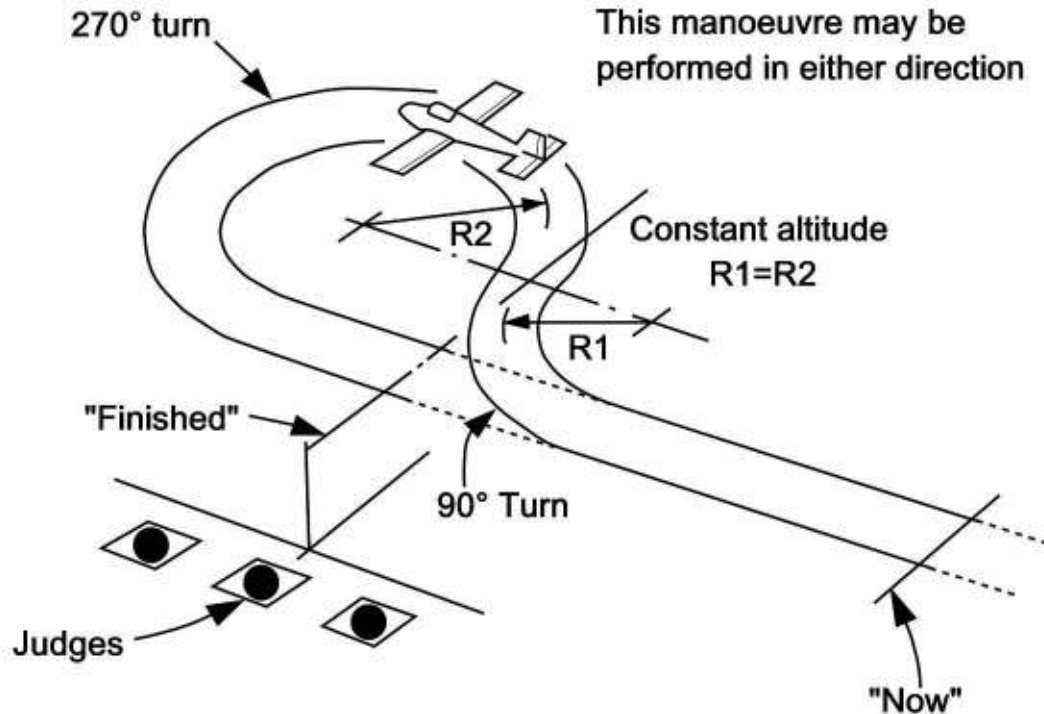

Errors:

1. Rate of turn is not constant.
2. The model aircraft changes altitude during the manoeuvre.
3. The model aircraft does not resume straight and level flight on the correct heading.
4. The model aircraft does not change from 90° to the 270° turn at the correct position.
5. The manoeuvre is too small or too large in reference to the type and scale of the model aircraft.
6. The manoeuvre is too close or too far away to be observed properly.
7. The manoeuvre is too high or too low to be observed properly.

AA Straight Flight at Low Speed

The model flies in a straight line, and parallel with the judges line, over the landing area for a minimum distance of 100 meters and centred on the judges position. The height must be constant and not exceed 6 metres and the model must fly at a speed which would represent the minimum safe flying speed for the prototype.

Prototypes fitted with retractable undercarriage must have the U/C extended.

If the prototype is fitted with any L/E or T/E flaps, slats, speed brakes, spoilers or other high drag/low speed/high lift devices then these must be deployed, unless the competitor can provide evidence that such devices were disabled or not routinely used.

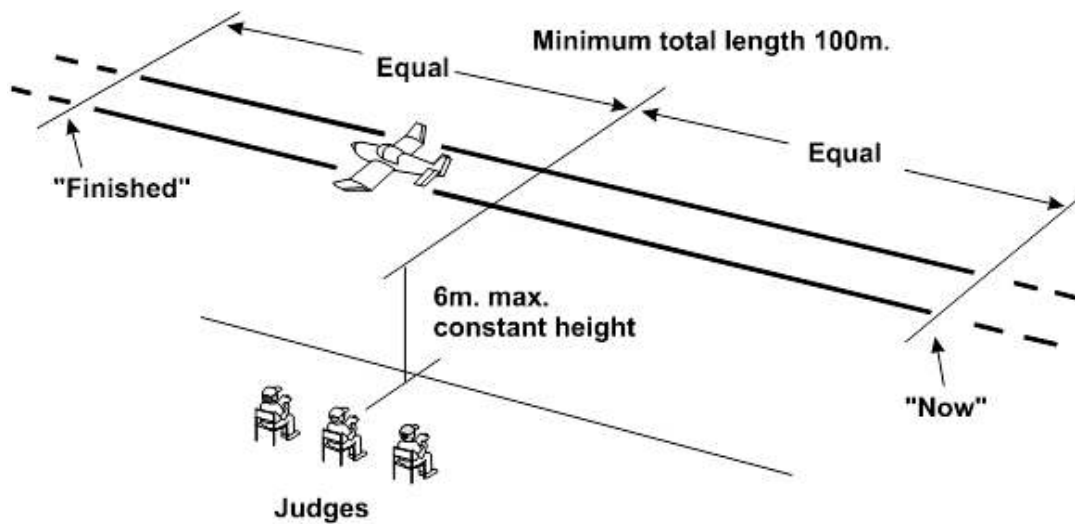
**Errors:**

1. Not a constant heading
2. Not a constant height.
3. Above 6 metres.
4. Model does not pass over the landing area.
6. Manoeuvre not centred on judges' position.
7. Not parallel with the judges' line.
8. Too short distance (too long is not an error).
9. Failure to extend U/C or deploy high drag/low speed/high lift devices.
10. Model flying too fast.